

Smappee EV Base

Installation manual



Document Accuracy

The specifications and other information in this document were verified to be accurate and complete at the time of its publication. Due to ongoing product improvement, this information is subject to change at any time without prior notice. For the latest information, see our online documentation: <https://www.smappee.com/downloads>

Table of contents

1. Introduction	4
2. Safety instructions.....	5
3. Models	7
4. Components.....	8
5. Technical specifications.....	10
6. Preparing the installation	13
7. Installation and activation	16
8. Using the EV Base.....	27
9. Declaration of conformity	31

1. Introduction

Thank you for purchasing this Smappee EV Base charging station for electric vehicles, the smartest charging station for businesses.

This installation and user manual tells you how to install and use the Smappee EV Base. We advise you to read the contents of this manual carefully, to ensure a safe and proper installation and enable you to use all the advanced features of this product to the full.

Support

Only qualified electricians or equivalent may install the Smappee EV Base. If you have any questions, please contact your service partner.

Please have the following information ready to hand to speed up the process: Article number and serial number which you can find on the identification label of the charging station.



Should your local distributor be unable to help you, or you have a suggestion for us, you can contact Smappee at: **support@smappee.com**.

Smappee n.v.
Evolis 104
8530 Harelbeke
Belgium

2. Safety instructions

Safety warning

Fully read and follow the safety instructions below before you install, service or use your Smappee EV Base. The installer must ensure that the charging station is installed in accordance with the relevant national and local regulations.

Carrying out activities on this charging station without the relevant knowledge and qualifications can lead to serious accidents and death. Only carry out tasks for which you are qualified and have been fully instructed.

Incorrect installation, repairs or modifications can result in danger to the user and may void the warranty and liability.

Safety precautions

	CAUTION: Risk of electric shock.
	CAUTION: Refer to the accompanying documentation whenever you see this symbol.

Please observe the following safety precautions to avoid potential electric shock, fire, or personal injury:

- The charging station is intended exclusively for charging electric vehicles and, when installed correctly, may be used by untrained individuals.
- Switch off electrical power supply to your charging station before installation or maintenance work.
- Do not use the charging station if damaged / defective.
- Do not immerse the charging station in water or any other liquids.
- Do not expose the charging station to heat, flame or extreme cold.
- Do not attempt to open, repair, or service any parts. Contact Smappee or your service partner for further information.
- Only use the charging station under the specified operating conditions.
- Do not allow children to operate a charging station.
- When a charging station is in use, adult supervision of any children present is required.
- While charging the charging cable must be completely unwound and connected to the electric car without overlapping loops. This to avoid the risk of overheating the charging cable.

Maintenance

- Observe the maintenance schedule.
- Clean the outside only with a dry, clean cloth.
- Do not use abrasive agents or solvents.
- May not be carried out during rain or if air humidity exceeds 95%.

Keeping order

- After charging store the charging cable properly so it does not present a tripping hazard.
- Make sure the charging cable cannot become damaged (kinked, compressed or driven over).
- Do not place any objects on the charging station.

Transport and storage

- Disconnect electrical power supply before removing the charging station for storage or relocation.
- Only transport and store the charging station in its original packaging. No liability for damage incurred will be accepted if the charging station is transported in non-standard packaging.
- Store the charging station in a dry environment within the temperature range specified in the technical specifications.

3. Models

Article no.	EAN	Description
EVB-2332-B-E	5425036932272	EV Base 3-phase 2 x 22 kW Socket
EVB-2332-BS-E	5425036932753	EV Base 3-phase 2 x 22 kW Socket with shutter
EVB-2332-C5-E	5425036932296	EV Base 3-phase 2 x 22 kW Type 2 cable 5m

4. Components

Components included

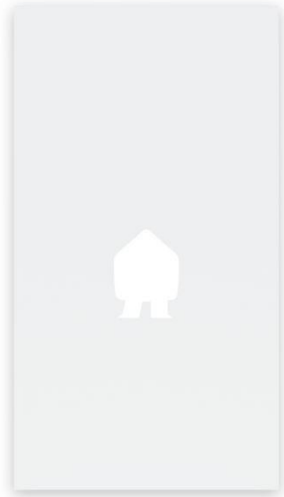

EV Base unit



Floor plate



QR code sticker

x2



Quick Install Guide



Concrete anchors

x4



Washers

x4



Screws

x4



Washers

x4

In case of fixed cable version:



Open-ended charging cable

x2



Cable gland

x2



Cable tie

x2

Identification label

The identification label of your charging station is located under the top cover of connector 1.

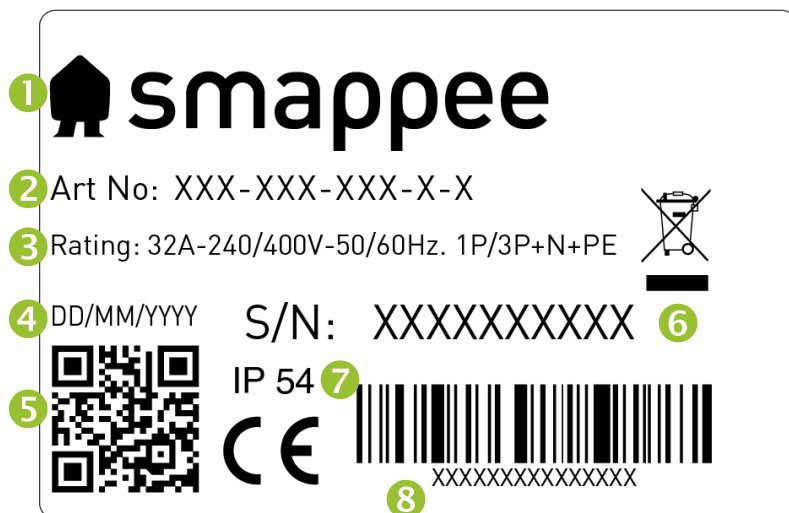

1. Manufacturer
2. Article number
3. Rating
4. Manufacturing date
5. QR code containing article number and serial number
6. Serial number
7. Degree of protection
8. EAN code

5. Technical specifications

Feature	Description
Technical features	
Charging capacity	Single or triple phase, 7.4 to 22 kW per connector
Output power	1-phase or 3-phase, 230 V – 400 V, 32 A per connector
Charge mode	Mode 3 (IEC 61851)
Connection case	Case B (Socket) or Case C (Fixed cable), depends on model.
Metering	MID certified class B
Integrated Residual Current Protection	Rated operating residual current detection: 6 mA DC / 30 mA RCD Type A
Supported power systems	TN-C, TN-C-S, TT, IT* * Caution: not all vehicles support the IT system. In this case or with 3x230V charging, a voltage transformer is required.
Grounding	TN system: PE wire TT system: Independently installed ground electrode < 100 Ohm spreading resistance IT system: connected to a shared reference (common earth) with other metal parts
Rated voltage (U_n)	230 V – 400 V
Rated insulation voltage (U_i) of a circuit	500 V
Rated impulse withstand voltage (U_{imp})	4 kV
Rated frequency (f_n)	50 Hz / 60 Hz
Rated current (I_{na})	32 A
Rated current (I_{nc}) of a circuit	32 A
EMC classification	Class B
Connection method	AC, permanently connected
Short circuit protection	Two connectors, Double power supply 3-phase: 2 x 32 A max 3P, type B or C
Interfaces & Connectivity	
Information status	RGB LED
Session activation	Plug & Charge, Scan QR code, Swipe RFID card, Smart EV schedules
Connectivity	Ethernet 100BASE-T

Communication protocol	OCPP 1.6 JSON, ready for update to OCPP 2.0
Certifications and Standards	
Product certification	CE
Standards	IEC 61851-1 (2017)
Environment	
Enclosure material	Aluminium (structure), Magnelis (back plate)
Enclosure standard colours	RAL9016 (star white) + RAL7021 (black grey)
Protection degree	IP 54
Mechanical impact protection	IK10
Pollution degree	3
Electrical safety class	I
Stand-by use	LED brightness 0%: 3 W LED brightness 100%: 18 W
Environmental conditions	Indoor and outdoor use
Operating temperature	-25 °C to 40 °C
Storage temperature	-25 °C to 60 °C
Relative humidity	0 % - 95 %, non-condensing
Maximum installation altitude	0 – 2.000 m
Access	Locations with restricted and non-restricted access
Physical properties	
Dimensions	1200 x 600 x 150 mm
Weight (excluding packaging)	EV Base structure: 28 kg Cable 5 m: 3 kg Socket: 0.9 kg
Charging cable length	2 x 5 m
Supply line connection	Terminal block, flexible conductors up to 6 mm ² or solid conductors up to 10 mm ²
Stationary / moveable	Fixed installation
External design	Enclosed assembly
Mounting method	Floor / Ground-mounted



The operating temperature assumes the ambient temperature of a product delivered in the default enclosure colours RAL9016 (star white) + RAL7021 (black grey). Direct exposure to sunlight may have an adverse effect on the temperature range.

If the product is exposed to lower or higher ambient temperatures, continuous operation cannot be guaranteed. If temperatures exceed the maximum values, the charging station will automatically decrease the charging current to decrease the internal temperature of the charging station.
This stabilises the internal temperature and makes it less likely that a transaction will be unexpectedly paused.

If the product is directly exposed to sunlight, the automated temperature management may automatically start below the maximum ambient temperature. Therefore, wherever possible, avoid exposing the charging station to direct sunlight.

Where products are exposed to the elements of nature, the enclosure can be subject to gradual aging of the material, which can result in product discolouration over time. Therefore, wherever possible, place the product in a sheltered place to optimise the life of the materials.

6. Preparing the installation

The first step is to prepare the physical installation of the EV Base as described in this chapter.

Installation prerequisites

- Calculate the existing electrical load to find the maximum operating current for the charging station installation. The Smappee EV Base is equipped with 2 connectors which need to be powered individually. Note that with the Smappee Overload functionality more charging stations or the total maximum operating current can be higher than the physical installation allows.
- Obtain all necessary permits from the relevant local authority.
- Refer to local wiring regulations to select the conductor sizes and use only copper conductors.
- Make sure that the installation area of the charging station is adequate for usability and ventilation purposes.
- Use the correct tools and provide sufficient material resources and protection measures.
- Make sure that there is an Ethernet based internet connection available for each EV Base (1 per unit).

Power supply

- The appropriate wire gauge of the supply cable depends on the power rating and distance between the meter cabinet and the charging station. The voltage drop must not exceed 5%. It is advisable to have a maximum voltage drop of 3 %.
- The maximum wire gauge that can be fitted is 6 mm² in case of flexible conductors or 10 mm² when solid conductors are used.
- The power supply trajectory from the circuit breaker panel up to the EV Base charging station must be protected against short-circuiting and over-current with B or C circuit breakers (or otherwise in compliance with local standards and regulations)
- A charging station connector must always be installed on a dedicated power circuit.
- When the power supply and the charging station are part of a TN-S system, the station must be grounded via the main distributor.
- Route the power supply cables to the position where the charging station will be installed together with an Ethernet cable for the internet connection.
- Make sure the power supply cables are positioned through central position of the floor plate recess.
- Make sure that there is at least 60 cm available out of the ground.
- Local regulations may be applicable and can vary depending upon the region or country.



Both power lines enter the charging station via the floor plate.

The Ethernet cable, used for the internet connection, enters the charging station via the floor plate.

The maximum power rating for each connector is specified in the table below.

Power per connector	Connection	Input current	Output current
7.4 kW	1-phase	1 x 32 A	1 x 32 A
22 kW	3-phase	3 x 32 A	3 x 32 A

Prepare the mounting foundation

The Smappee EV Base is designed to be installed at ground level without the need for a separate mount.

A stable and level ground needs to be prepared in advance. We advise a levelled concrete foundation at ground level. It is also possible to have the foundation a little lower than ground level. This allows the anchors to be masked and the EV Base to be integrated in the surrounding soil.



Depending on the subsoil, the size may vary. Please refer to the technical specifications of size and weight to determine and construct a solid foundation for the EV Base.

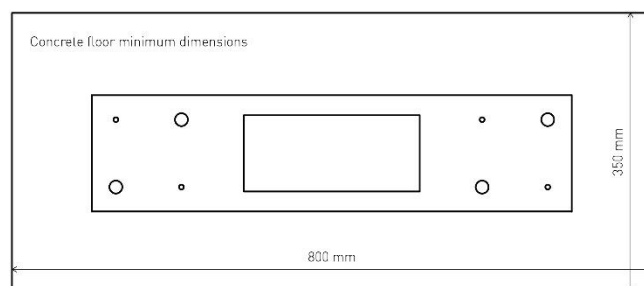
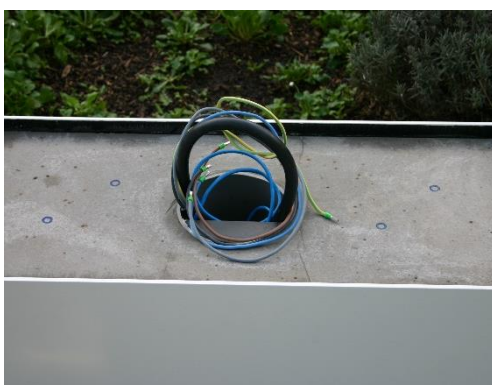

Make sure the power supply cables and Ethernet cable are positioned through central position of the floor plate recess.

Tools (not included)

- Screwdrivers and a 2.5mm Hex screwdriver
- Multimeter and earth ground meter
- Wire stripper and cutter.
- Needle-nose pliers.
- Ferrules crimper, for stranded power supply cables
- Drill and rock drill diameter 12 mm.
- 19 mm socket wrench with ratchet handle
- Hammer

Supplies (included)

- 4 x concrete anchors (\varnothing 12 mm x 100 mm)
- 4 x washers (\varnothing 50 mm)
- 4 x M6 bolts and washers
- 2 x cable ties for strain relief
- 2 x M32 cable gland

Supplies (not included)

- Ethernet cable or RJ45 connector for wired communication.
- Power supply cables
- Ferrules (6 mm²), for stranded power supply cables

7. Installation and activation

This procedure describes the required steps for the physical installation of the EV Base.

	CAUTION: The installation must be carried out by a qualified professional who has read this manual and works in compliance with IEC 60364 standards. Neglecting this may lead to severe injuries or hazardous situations while working with electricity.
	CAUTION: The electric system must be entirely disconnected from every power source prior to performing installation or maintenance work. Make sure it is not possible to connect the electric current during installation. Put up caution tape and warning signs to mark the work areas. Make sure no unauthorised people can enter the work areas.
	CAUTION: The charging station contains electric components that may still contain electrical charge after being disconnected. Wait at least 10 seconds after disconnection before commencing work.
	CAUTION: Adaptors or conversion adaptors and cord extension sets are not allowed to be used.

Unbox the EV Base

For safe and compact transport of the EV Base, the floor plate is mounted to the EV Base and the charging cables are stored within the EV Base together with the supplies (concrete anchors, washers, cable ties,...).

- a. In order to dismount the floor plate, remove the four M6 bolts and washers. Store the bolts and washers in a safe location for further use.

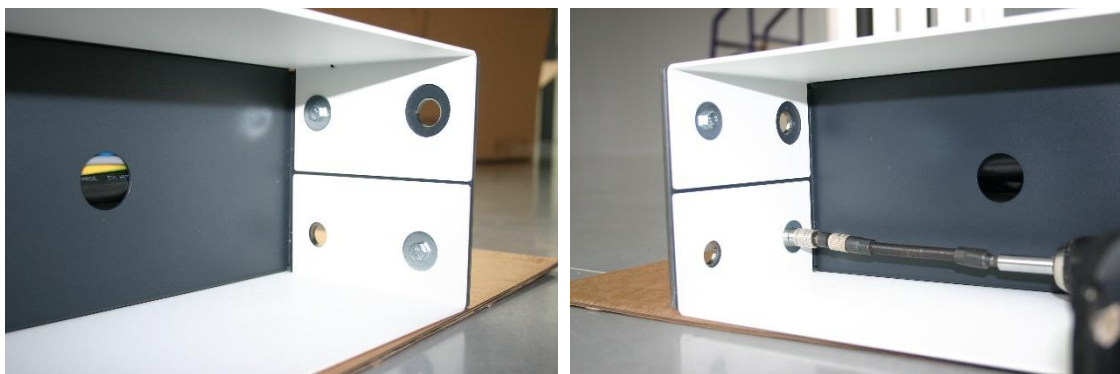

- b. Cut the cable tie securing the charging cables to the floor plate.

- c. The floor plate is now separated from the EV Base and charging cables can be removed from the EV Base, together with the supplies (concrete anchors, washers, cable ties,...).

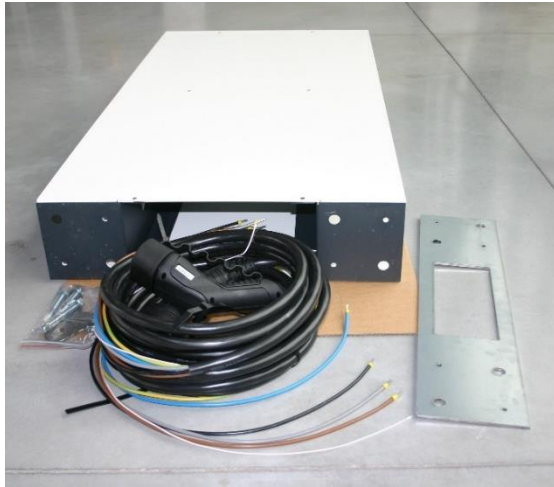

Mount the anchors

- a. Use the floor plate to mark the position of the anchors on the pre-prepared concrete foundation. Make sure the top side label of the floor plate is facing upwards. The power supply cables and Ethernet cable should go through the central recess of the floor plate.

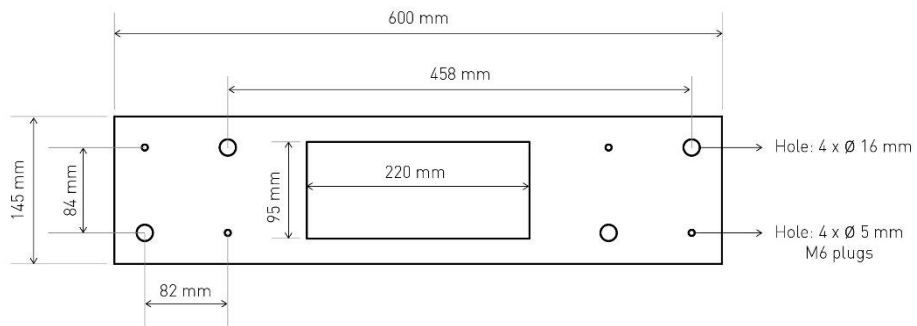
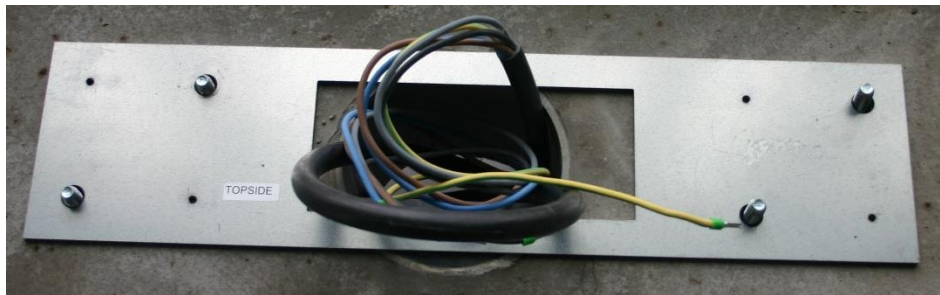

- b. Drill 4 holes of 12 mm diameter through the slots to a depth of 70 mm. Insert the supplied concrete anchors. Make sure that there is approximately 3 cm of threaded wire visible above ground level. Do not drill holes for the 4 remaining 5 mm slots.



- c. Mount the floor plate over the anchors and make sure it is level in both directions. If not, tilt the floor plate until it becomes level.

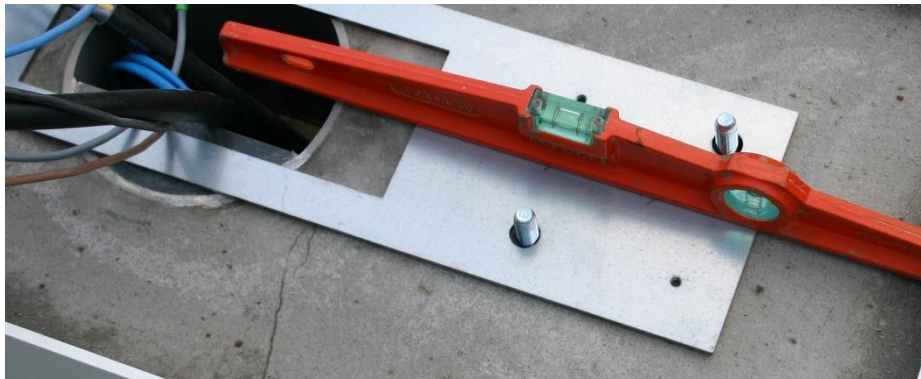

To tilt the floor plate, insert large washers below the floor plate until it becomes level.



Place the EV Base in position

- a. Remove the backplate of the EV Base and put it at a safe location where it cannot be scratched or damaged otherwise; for instance in the packaging of the EV Base.

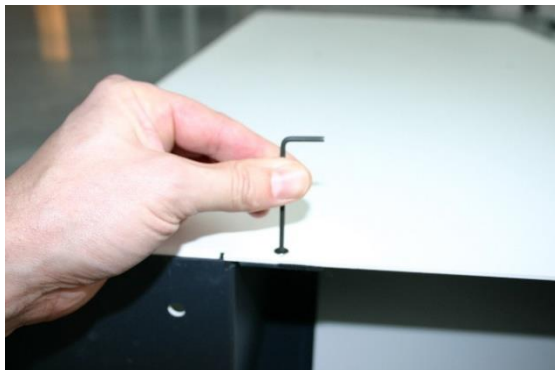

- b. Position the EV Base on the floor plate.
- c. Position one of the four supplied large washers (\varnothing 50 mm) over each of the 2 front screw threads (anchors).
- d. Place two nuts on the front screw threads and hand tighten.



Do NOT torque the nuts yet. This is done in the last step of the installation, when the back cover of the EV Base is in place.

Power supply connection

- a. Cut both the power supply cables to adequate length and add the ferrules to each conductor.
- b. Measure the resistance of the grounding circuit and make sure that it is within acceptable limits. If necessary, install a grounding point closer to the charging station.
- c. Connect each supply cable to the correct terminal block indicated with L1, L2, L3, N and PE.

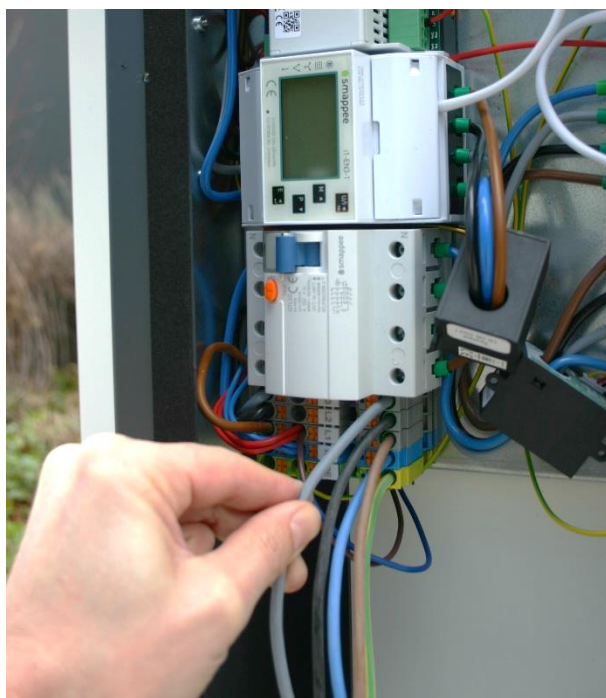

Phase rotation

To avoid overloading the first phase with one-phase electric vehicles, phase rotation is recommended. We recommend rotating the phases as shown in the table below.

EV Base	Connector	Phase mapping
EV Base 1	Connector 1	L3 – L2 – L1 – N (as indicated on the label)
	Connector 2	L1 – L3 – L2 – N
EV Base 2	Connector 1	L2 – L1 – L3 – N
	Connector 2	L3 – L2 – L1 – N (as indicated on the label)
EV Base 3	Connector 1	L1 – L3 – L2 – N
	Connector 2	L2 – L1 – L3 – N

And continue with this pattern for other EV Base units.



When phase rotation is applied on a connector adjust the configuration in the Smappee Dashboard.

Single-phase installation

In case only one phase is available from the power supply, it is possible to install an EV Base as a single-phase charging station. In this case, the one available phase should be connected to L1. Do not connect anything to L2 and L3. The neutral and protective earth should be connected to N and PE respectively.

EV charging cable mounting (only fixed cable version)



This section is only relevant if the EV Base comes with a fixed cable. If you have a socket version, please continue to the next section.

- a. Mount the fixed charging cables through the M32 cable glands on the left and right side of the EV Base. Mount the power supply wires to the terminal block. Do not forget to connect the small white CP data cable. The CP cable is white, except for products purchased before January 2022 which have an orange CP cable.



- b. Mount the cable tie for strain relief on the charging cable after it enters the M32 cable gland.





The length of the fixed cable can be shortened if required. Cut the cable to its required length and add ferrules (not supplied).

Internet connectivity

An Ethernet cable is used for internet connection, mount the Ethernet cable in the Smappee Connect. Cut the Ethernet cable to the appropriate length and mount an RJ45 connector (not supplied).

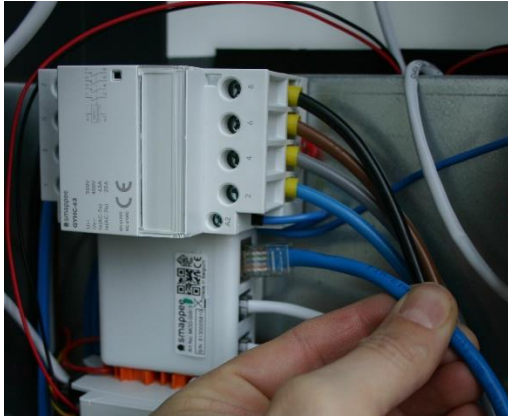

Fix the QR codes



This section is only relevant if the EV Base will be used with 'Scan and Charge' as a way of charging. If you won't use this method, please continue to the next section.

The two supplied QR codes need to be put on top of the Smappee EV Base. Fix the QR code near the corresponding connector to make sure the driver scans the correct QR code.



Switching on the EV Base

- a. Check all connections are secure and power-up both power supplies of the EV base.
- b. Check the status LEDs:
 - Charging controllers: green flashing light (1 x per 3 seconds)
 - RCM: continuous green light

- Snappee Connect: blue flashing
- MID meters: Display is lighting up

Activation

This procedure is done with the Smappee Energy Monitor mobile app. You can download this from the Apple App Store for iOS or the Google Play store for Android phones.



The Smappee App will guide you through the various steps to fill in all the required information.

- Log in to the Smappee App with the corresponding Smappee username or create a new user account.
- Install a Smappee EV Base
- Follow the steps shown in the mobile app.

	<p>Multiple charging stations can be installed at a single location. To add a new charging station in the mobile app, go to Settings > Your Smappee charging stations</p>
	<p>The settings of your charging station can be adjusted in the Smappee Mobile app or Dashboard.</p> <ul style="list-style-type: none">• Smappee Mobile App: Name, Maximum current per connector, Charging speed per connector and LED brightness• Dashboard: Name, Maximum current per connector, Phase assignment per connector, Charging speed per connector and LED brightness
	<p>For overload protection or optimised self-sufficiency additional Smappee Infinity components must be installed to measure the Grid and Solar, Battery or other submetering if applicable.</p>

Closure

- a. Mount the back plate into position and tighten the screws.



If the screw holes do not align, loosen the anchor nuts to eliminate any torsion in the frame.

- b. Position one of the four supplied large washers (\varnothing 50 mm) over each of the 2 rear screw threads (anchors).
- c. Place two nuts on the rear screw thread.
- d. Mount the 4 remaining M6 bolts and washers to secure the EV Base with the floor plate
- e. Tighten all anchor nuts and bolts with a wrench.



f. Finish off by using the preferred top coat.



8. Using the EV Base

There are three ways of charging using a Smappee EV Base:

1. Plug & Charge: Simply insert the connector in the EV and start charging.
2. Swipe & Charge: Insert the connector, swipe your RFID card and start charging.
3. Scan & Charge: Insert the connector, scan the QR code in the Smappee app and start charging.

Below you can find the different charging sequences.

	Each EV Base that is installed and activated is Plug and charge. Changing the Session Activation Method is done using the Smappee Dashboard. Changing the authentication methods can be done remotely.
	Scan and charge and Swipe and charge (with Smappee CSMS) can only be used when a Smappee Payment Agreement has been signed. Please contact your Business Developer for more info.

Plug & Charge

The charging station is freely accessible without the need to authorize. Anyone can plug their car into the charger and start charging for free.

Start charging



Stop charging



Swipe and charge

Charging sessions can be started using an RFID card. You can either use a Smappee Smart Charge Card for free charging or (if activated) a third party eMSP card to pay for charging sessions.

The RFID readers are situated at the side of the EV Base, close to the connector.

- **Whitelist:** charging is free with a Smappee Smart Charge Card or any other authorized RFID card. Once the charging cable is plugged-in, the user simply swipes their RFID card and the free charging session begins. All authorized cards must first be added to the whitelist using the 'Whitelisting' card on dashboard.smappee.net. See [this](#) article for more information. Cards can be ordered via the Smappee dashboard.
- **Public charging:** other EV drivers can use this charging station and pay with a payment card from a third-party eMSP such as Shell Recharge or Plugsurfing . This can be done through Smappee's own CPO or through a third-party CPO. Public charging is activated using the Smappee dashboard. See the [Smappee Academy](#) for more information.
- **Split Billing:** This is aimed at employees who charge their company car at home and need to be reimbursed for the electricity consumption. Split billing agreements must be made for each employee. Starting a charging session is similar to whitelisting but at the end of each month, Smappee Services will send a bill for all employees' charging sessions to the company. All individual employees will be reimbursed according to the amount of kWh charged. Split billing is activated using the Smappee dashboard. See [this](#) article or the [Smappee Academy](#) for more information.

Start charging



Stop charging



Scan and charge

The user pays by credit card (Visa or Mastercard) using the Smappee app. They scan the QR code shown on the charging station and the app will guide them through the process of starting the charging session. It is also possible to set discount rates for specific users. Scan and charge is activated using the Smappee dashboard. See the [Smappee Academy](#) for more information.

Start charging

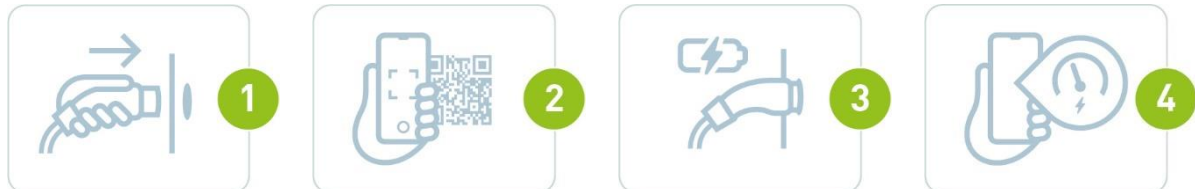









Stop charging



More information on how to use the Smappee EV Base can be found on: support.smappee.com/hc > Smappee EV Line

LED status

LED colour	LED status	Meaning	Action of the user
	White continuous	The Smappee EV Base is available.	Connect your EV with the Smappee EV Base.
	Blue continuous	Your EV is connected with the Smappee EV Base, but is not yet charging.	<ul style="list-style-type: none"> • If using an RFID, scan your charge card and wait until the LED turns flashing blue. • If using QR codes, scan the QR code and wait until the LED is green pulsing. • If no authorisation is required, wait until the LED becomes green pulsing.
	Blue flashing	Your RFID card is being verified.	Wait until the LED is green pulsing.
	Green pulsing	The Smappee EV Base is charging your EV.	Your EV is being charged.
	Green continuous	The EV is now fully charged.	Disconnect the cable and put it back in its socket of the Smappee EV Base.
	Green blinking	Charing session is paused by Smappee Smart Charging	This is informative, no action required.
	Red continuous	The Smappee EV Base is unavailable.	Check the manual or contact your supplier for more info and further steps.
	Red flashing	Your charge card is not authorised.	Contact your charge card supplier.

9. Declaration of conformity

We,

Smappee nv
Evolis 104
B-8530 Harelbeke
Belgium

following the provision of the following EC Directives:

- 2014/35/EU The Low Voltage Directive
- 2014/30/EU The Electromagnetic Compatibility Directive
- 2014/32/EU Measuring Instrument Directive
- 2011/65/EU RoHS Directive

hereby declare that the product:

EVB-2332-B-E, EVB-2332-BS-E, EVB-2332-C2-E, EVB-2332-C5-E

is in conformity with the applicable requirements of the following documents

* Metering :

EN50470-1 :2006 / EN50470-3 :2006

* Emissions:

(EN61326-1 : 2013)

Radiated Emission: EN 55011:2009 / EN 55032:2015 (Class B)

Conducted Emission: EN 55011:2009 / EN 55032:2015 (Class B)

Harmonic current Emission: EN 61000-3-2:2005 +A1:2008 + A2:2009

Flicker: EN 61000-3-3:2008

* Immunity:

(EN61326-1 : 2013)

ESD : EN 61000-4-2:2008 / EN 61000-4-2 :2009

Radiated immunity : EN 61000-4-3:2006 + A1:2007 + A2: 2010

Power frequency magnetic field: EN 61000-4-8:2009

Voltage dips/interruptions: EN 61000-4-11:2004

Common Mode Immunity: EN 61000-4-6:2008 / EN 61000-4-6:2009

Burst : EN 61000-4-4:2004 / EN 61000-4-4:2012

Surge: EN 61000-4-5:2005 / EN 61000-4-5:2006

* Safety:

Metering Function : IEC 61010-1 Ed 3.0 (2010-06) + A1:2016

AC Charging equipment : IEC 61851-1 (2017) / EN61558-1

Authorized signatory



Stefan Grosjean
CEO